



ASTA Door Corporation

ASTA Door Corporation
4255 McEver Industrial Drive
Acworth, GA 30101
Phone: (770) 974-2600
Fax: (770) 974-1455
Web Site: www.astadoor.com

Installation Instructions Models 400 & 600 Rolling Steel Service Door

USE ASTA DOOR CORPORATION PARTS ONLY - ALL OTHERS SHALL VOID WARRANTY

IMPORTANT REMARKS ALL ASTA PRODUCTS MUST BE INSTALLED BY A LICENSED, QUALIFIED PROFESSIONAL DOOR COMPANY TO QUALIFY FOR OUR WARRANTY. INSTALLATION WITHOUT PROPER TOOLS AND KNOWLEDGE CAN RESULT IN PERSONAL INJURY. THIS PAMPHLET IS DESIGNED TO ASSIST A PROFESSIONAL IN THE INSTALLATION OF ASTA MODEL 400 & 600 ROLLING STEEL SERVICE DOORS. SAFETY IS FOREMOST. INSTALLATION SHOULD BE EXECUTED BY LICENSED, QUALIFIED DOOR PROFESSIONALS. INSPECT ALL OF THE SHIPPED PARTS AND ACCOUNT FOR EVERYTHING BEFORE COMMENCING ANY WORK. FOR QUESTIONS AND TECHNICAL ASSISTANCE, CONTACT ASTA CUSTOMER SUPPORT AT (770) 974-2600.

WARNING

MOVING DOOR can cause serious injury or death.
Keep clear of opening while door is moving.



SAFETY INSTRUCTIONS

1. Do Not stand or walk under moving door. Keep door in full view and free of obstructions while operating.
2. Do Not allow children to operate the door or automatic operator.
3. Repairs or adjustments should be made by a trained service person using proper tools and instructions.
4. To avoid injury, do not put fingers between door and guides.
5. Read owner's manual for your door and operator for more information.



CAUTION: USE CORRECT LIFTING PROCEDURES AND EQUIPMENT DURING INSTALLATION OF THIS PRODUCT TO AVOID INJURY OR DAMAGE.

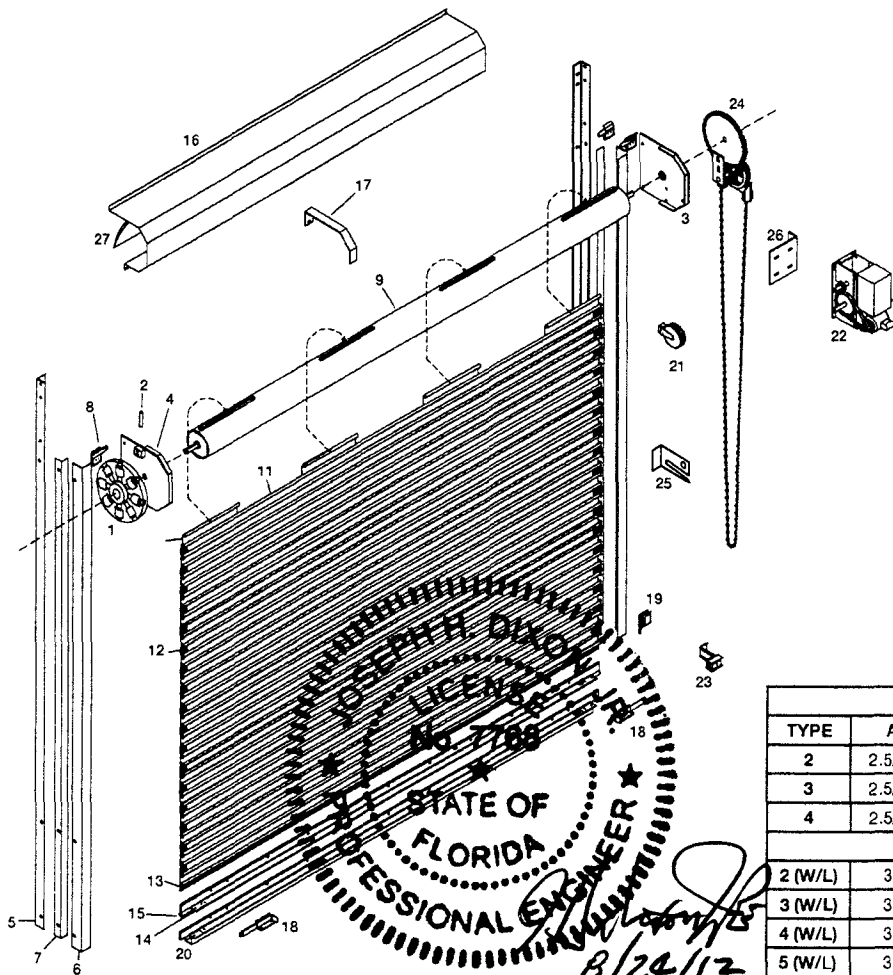

GUIDE DETAIL (NON-WINDLOCK)

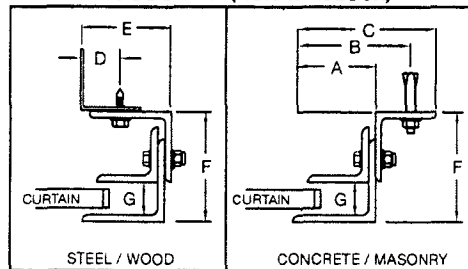

GUIDE DETAIL (WINDLOCK)

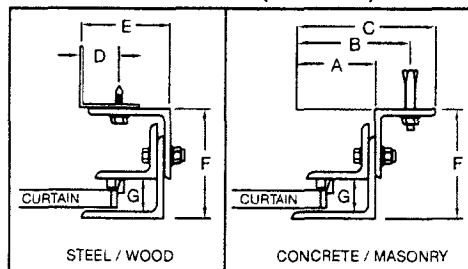

GUIDE DIMENSIONS - FACE OF WALL

TYPE	A	B	C	D	E	F	G
2	2.5/8"	3.7/8"	5.1/8"	1.1/4"	2.13/16"	4"	1.1/4"
3	2.5/8"	4.3/4"	5.5/8"	1.1/4"	2.13/16"	4.3/8"	1.1/4"
4	2.5/8"	4.3/4"	5.5/8"	1.1/4"	2.7/8"	4.3/4"	1.1/4"
2 (W/L)	3"	4.1/4"	5.1/2"	1.5/8"	3.3/16"	4"	1.1/2"
3 (W/L)	3"	5.1/8"	6"	1.5/8"	3.3/16"	4.3/8"	1.1/2"
4 (W/L)	3"	5.1/8"	6"	1.5/8"	3.1/4"	4.3/4"	1.1/2"
5 (W/L)	3"	5.1/8"	6"	1.5/8"	3.1/4"	4.3/4"	1.1/2"
6 (W/L)	5.1/4"	6.1/2"	7.3/4"	1.5/8"	4.7/8"	7.1/4"	1.1/2"

PARTS LIST

1	TENSION WHEEL ASSEMBLY	VARIABLES	11	SLAT (FLAT OR CURVED)	VARIABLES	21	TAKE-UP REEL (OPTIONAL)	VARIABLES
2	TENSION WHEEL PIN	VARIABLES	12	ENDLOCK / WINDLOCK	VARIABLES	22	ELECTRIC OPERATOR (OPTIONAL)	VARIABLES
3	HEADPLATE (DRIVE SIDE)	VARIABLES	13	BOTTOM SLAT	VARIABLES	23	PHOTO EYES (OPTIONAL)	VARIABLES
4	HEADPLATE (TENSION SIDE)	VARIABLES	14	BOTTOM BAR	VARIABLES	24	REDUCTION DRIVE HOIST	VARIABLES
5	WALL ANGLE	VARIABLES	15	ASTRAGAL BULB	450703	25	HAND CHAIN KEEPER	420405
6	INNER ANGLE	VARIABLES	16	HOOD	VARIABLES	26	MOTOR MOUNT BRACKET (OPT.)	440002
7	OUTER ANGLE	VARIABLES	17	HOOD SUPPORT BRACKET	VARIABLES	27	HOOD BAFFLE (OPTIONAL)	610623
8	REMOVABLE HEADSTOPS	VARIABLES	18	SLIDE BOLT LOCKS (OPTIONAL)	280106	28	GUIDE WEATHER SEAL (OPT.)	400103
9	BARREL ASSEMBLY	VARIABLES	19	INTERLOCK SWITCH (OPTIONAL)	VARIABLES	29		
10	STARTER SLAT 20 GA.	VARIABLES	20	SAFETY EDGE (OPTIONAL)	VARIABLES	30		

Professional Engineer
Joseph H. DeLeon
No. 7788
STATE OF FLORIDA
8/24/12

STEP 1 - PREPARATION

- 1.1 CHECK THE WIDTH AND HEIGHT OF THE DOOR OPENING WITH THE PACKING LIST.
- 1.2 CHECK IF THE DOOR JAMBS ARE PLUMB.
- 1.3 CHECK IF THE FLOOR AND HEADER ARE LEVEL.
- 1.4 CHECK DIMENSIONS FOR APPROPRIATE SIDE ROOM AND HEADROOM REQUIREMENTS.
- 1.5 THE WALL ANGLES IN STEP 2 MUST BE INSTALLED PLUMB AND LEVEL TO EACH OTHER EVEN IF JAMB IS NOT PLUMB AND FLOOR IS SLOPED.

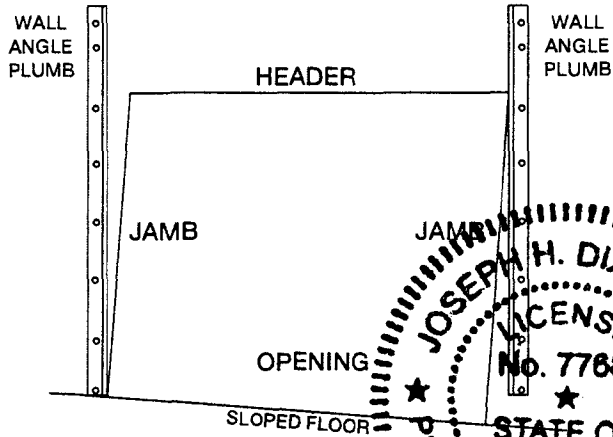

STEP 2 - WALL ANGLES

- 2.1 EVENLY SPACE WALL ANGLES OUTSIDE OPENING SO DISTANCE BETWEEN THEM IS AS SHOWN BELOW.

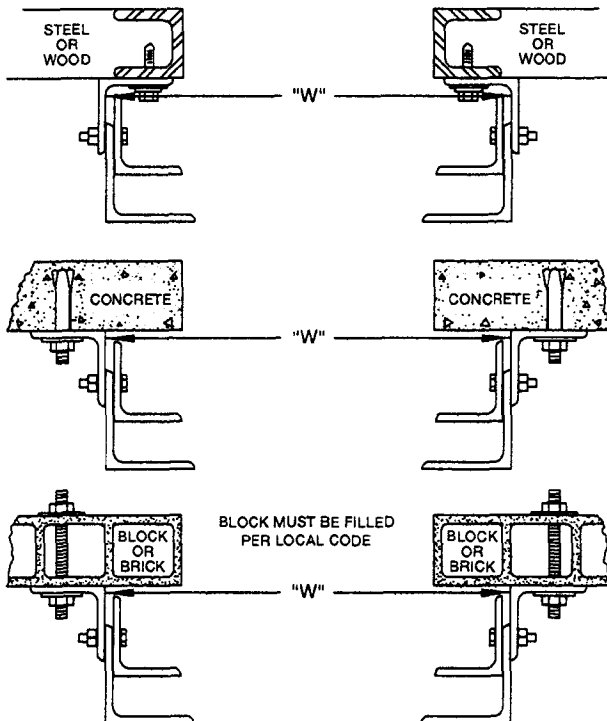

GUIDE TYPE	"W" DIMENSION
ALL NON-WINDLOCKS	BARREL + 1"
MALLEABLE WINDLOCKS	BARREL + 1.3/4"
10 IN. DIAMETER BARREL	BARREL + 2"

- 2.2 FASTEN THE WALL ANGLES TO JAMBS ACCORDING TO THE FOLLOWING TABLE:

JAMB	FASTENER (SUPPLIED BY OTHERS)
STEEL	DRILL .339 (R) DIA. HOLES FOR 3/8" SELF TAPS. DRILL 5/16" DIA. HOLES AND TAP 1/2"-13 FOR 1/2" BOLT.
WOOD	LAG BOLTS 3/8" X 3.1/2"
CONCRETE	EXPANSION BOLTS, 1/2" X 3"
BLOCK OR BRICK	THRU-BOLTS OR ALL THREAD 1/2"

NOTE FOR WINDLOAD CERTIFIED DOORS REFERENCE WINDLOAD DRAWINGS FOR ANCHOR TYPE AND PLACEMENT.

STEP 3 - BARREL ASSEMBLY

RIGHT HAND OPERATION SHOWN THROUGHOUT. LEFT HAND OPPOSITE.

- 3.1 FIT DRIVE SIDE HEADPLATE ONTO DRIVE AXLE OF BARREL AS SHOWN BELOW. THE DRIVE END OF THE BARREL HAS NO AXLE BEARING AND NO COUNTERBALANCE SPRING. THE DRIVE SIDE HEADPLATE HAS A BALL BEARING ATTACHED. LEFT END OF BARREL IS PAINTED RED REGARDLESS OF WHETHER IT IS THE DRIVE SIDE OR THE SPRING TENSION SIDE.

FIT TENSION SIDE HEADPLATE ONTO SPRING AXLE AS SHOWN BELOW. THE SPRING END OF THE BARREL HAS BEARING AND A COUNTERBALANCE SPRING. THE SPRING SIDE HEADPLATE HAS NO BEARING.

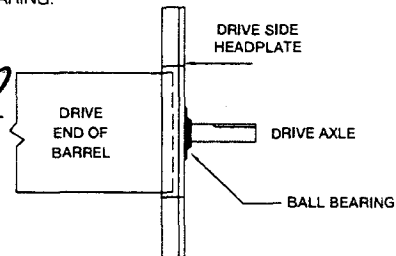

- 3.3 FIT TENSION WHEEL ONTO SPRING AXLE AND INSERT KEYSTOCK. DO NOT INSERT LOCKING PIN OR TIGHTEN SETSCREW AT THIS TIME.

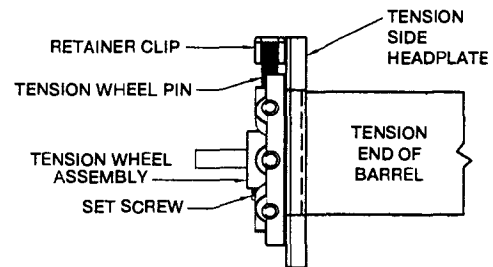

CAUTION: KEY MUST BE COMPLETELY INSERTED INTO TENSION WHEEL OR DAMAGE AND INJURY COULD OCCUR.

STEP 4 - DRIVE ASSEMBLY

- 4.1 FIT DRIVEN SPROCKET ONTO DRIVE AXLE. DO NOT INSERT KEY INTO KEYWAY OR TIGHTEN SETSCREW AT THIS TIME.
- 4.2 FASTEN DRIVE ASSEMBLY TO DRIVE SIDE HEADPLATE WITH TWO 1/2" FLAT HEAD BOLTS, FLATWASHERS AND NUTS. DO NOT TIGHTEN BOLTS AT THIS TIME.
- 4.3 SLIDE HEADPLATE UP AGAINST BARREL SPACER AND ALIGN DRIVEN SPROCKET WITH DRIVE SPROCKET.
- 4.4 INSTALL ROLLERCHAIN ONTO DRIVE AND DRIVEN SPROCKETS AND SECURE MASTER LINK.
- 4.5 INSERT KEY COMPLETELY INTO DRIVEN SPROCKET KEYSEAT.

SINGLE REDUCTION

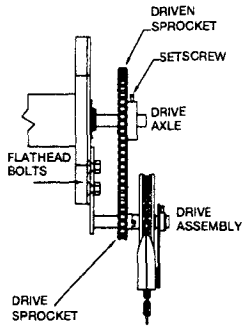

DOUBLE REDUCTION

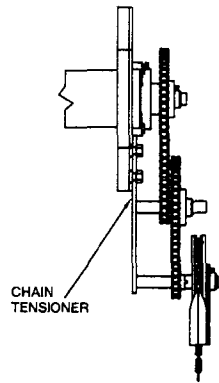

TRIPLE REDUCTION

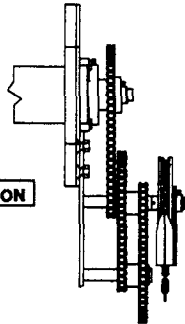

STEP 5 - MOUNTING BARREL ASSEMBLY

- 5.1 RAISE COMPLETE BARREL ASSEMBLY WITH A MECHANICAL HOIST OR A FORKLIFT AND FASTEN HEADPLATES TO **INSIDE** OF WALL ANGLES AS SHOWN WITH THE 1/2" BOLTS, LOCKWASHERS, AND NUTS PROVIDED. USE FLAT HEAD BOLTS WHERE COUNTERSUNK HOLES ARE FOUND.

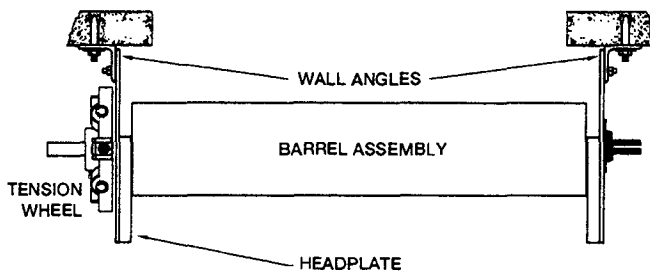

- 5.2 SPACE PIPE EQUALLY BETWEEN HEADPLATES.
 5.3 ALIGN DRIVE AND DRIVEN SPROCKETS.
 5.4 ADJUST TENSIONER AND TIGHTEN BOLTS.
 5.5 TIGHTEN DRIVEN SPROCKET SETSCREW.
 5.6 ADJUST POSITION OF TENSION WHEEL ON SPRING AXLE TO WITHIN 1/4" OF HEADPLATE AND TIGHTEN SETSCREW. DO NOT INSERT PIN IN TENSION WHEEL AT THIS TIME.

STEP 6 - MOUNTING CURTAIN ASSEMBLY

- 6.1 RAISE CURTAIN ASSEMBLY WITH MECHANICAL HOIST OR FORKLIFT AND HANG IT ONTO BARREL WITH INSTALLATION BELTS. USE PADDING ON LIFTING MECHANISM TO AVOID DENTING ANY SLATS.

- 6.2 HOOK STARTER SLATS ONTO ATTACHMENT BARS AND FASTEN WITH 5/16" - 18, 1/2" LONG BOLTS AND FLATWASHERS AS SHOWN IN FIGURE TO RIGHT.

- 6.3 PULL HAND CHAIN TO ROLL CURTAIN ONTO BARREL WHILE ASSISTING TENSION WHEEL TO ROTATE FREELY.



CAUTION: SECURE HAND CHAIN TO KEEPER SO CURTAIN WILL NOT UNCOIL DURING TENSIONING PROCEDURE. KEEP CURTAIN CLOSE TO WALL AND AWAY FROM HOOD BANDS.

KEEP INSTALLATION BELTS IN PLACE UNTIL PROPER TENSION HAS BEEN APPLIED.

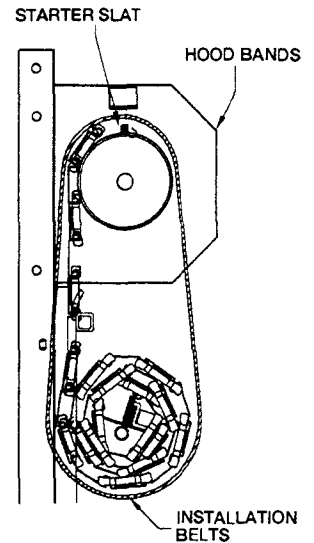

- 6.4 APPLY 1 TO 2 COMPLETE TURNS OF TENSION TO THE TENSION WHEEL BY ALTERNATELY PULLING DOWN ON THE STEEL BAR, AND INSERTING THE PIN, AS SHOWN BELOW. (SEE TENSION DECAL ON TENSION SIDE HEADPLATE FOR PRE-TURN REQUIREMENTS.)

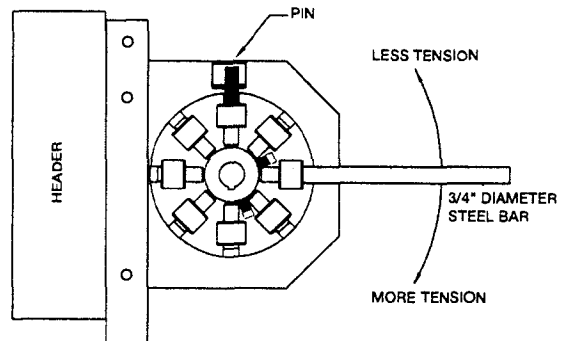

CAUTION: TEST DOOR AND ADJUST TENSION AS NEEDED FOR PROPER CURTAIN BALANCE. LARGE DOORS MAY REQUIRE ADDITIONAL TURNS OF TENSION. APPLY MORE OR LESS TENSION IN 1/8 TURN INCREMENTS.

STEP 7 - ATTACH HEADSTOPS

- 7.1 LOWER CURTAIN INTO GUIDE CHANNELS THAT THE BOTTOM BAR IS APPROXIMATELY 6" BELOW WHERE THE HEADSTOPS ATTACH TO THE INNER ANGLE AND RESECURE HAND CHAIN.
 7.2 ATTACH HEADSTOPS TO INNER GUIDE ANGLE USING TWO 5/16" X 5/8" HEX BOLTS AND 5/16" LOCK WASHERS.
 7.3 APPLY GREASE IN THE GUIDE CHANNEL TO ALLOW FREE CURTAIN MOVEMENT.

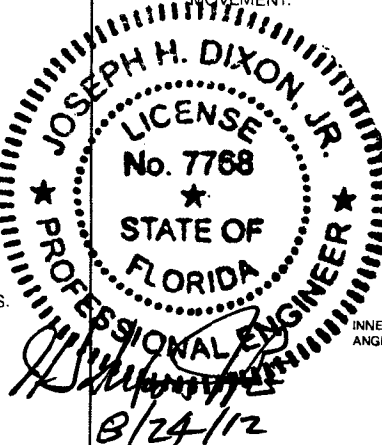
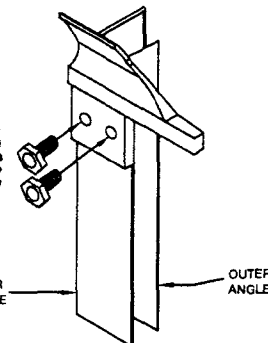

STEP 8 - HOOD

- 8.1 IF THE PROVIDED HOOD IS A SINGLE PIECE OR FACTORY COMBINED MULTIPLE PIECES, THEN SKIP TO INSTRUCTION 8.4.
- 8.2 IF HOOD WAS PROVIDED IN TWO OR MORE PIECES, THEN OVERLAP THE PIECES SO THAT COMBINED HOOD LENGTH IS EQUAL TO THE MEASURED DISTANCE BETWEEN THE HEADPLATES AS SHOWN.

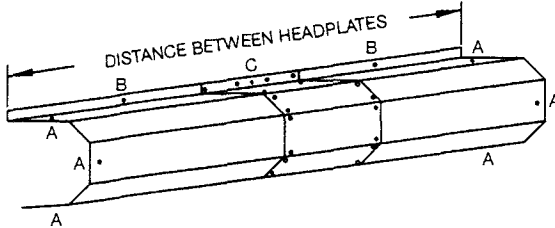

- 8.3 FASTEN OVERLAPPED AREA TOGETHER WITH FOUR POP RIVETS IN EACH FLAT SECTION. (28 RIVETS TOTAL)
- 8.4 ONCE ASSEMBLED, RAISE HOOD WITH MECHANICAL HOIST OR FORKLIFT AND FASTEN TO HEADPLATES AND HEADER.
- 8.5 FASTEN HOOD TO HEADPLATES AT LOCATION "A" WITH 1/4" SELF TAPPING SCREWS.
- 8.6 FASTEN HOOD TO HEADER AT "B".
- 8.7 HOODS OVER 18' LONG REQUIRE ANOTHER FASTENER AT LOCATION "C".
- 8.8 WHEN HOOD SUPPORT BRACKETS ARE SUPPLIED, INSTALL AT LOCATIONS "B" OR "C" AS NEEDED. FASTEN HOOD TO BRACKET AT LOCATION "D".

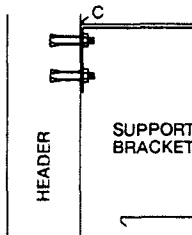

STEP 9 - HANDCHAIN

- 9.1 ADJUST HANDCHAIN LENGTH SO THAT IT HANGS BETWEEN 1 AND 2 FEET OFF THE GROUND.
- 9.2 FASTEN HANDCHAIN LATCH APPROXIMATELY 4' OFF THE GROUND.

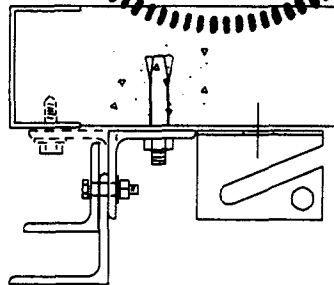

STEP 10 - SLIDE BOLT LOCK (OPTION)

- 10.1 REMOVE BOLTS AT LOCATIONS "A" AND "B" FOR FACTORY-PREPARED DOORS.
- 10.2 IF NOT FACTORY PREPARED, REMOVE EXISTING BOLTS AND DRILL 5/16" HOLES AT THE SPECIFIED LOCATIONS.
- 10.3 ALIGN SLIDE LOCK AND STEEL COVER WITH THE HOLES.
- 10.4 FASTEN THE SLIDE LOCK MECHANISM WITH THE SUPPLIED HARDENED STEEL CARRIAGE BOLTS.
- 10.5 FOR EXTRA SECURITY, WELDING THE COVER TO THE BOTTOM ANGLE IS RECOMMENDED.

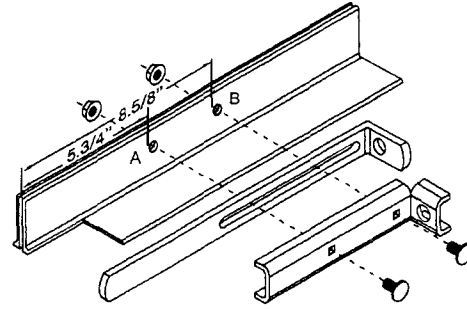

STEP 11 - GUIDE WEATHERSEAL (OPTION)

- 11.1 ATTACH PVC GUIDE WEATHERSEAL TO THE OUTER ANGLE PER DIAGRAM.
- 11.2 IF GUIDE WEATHERSEAL IS ORDERED FROM FACTORY, THE BOTTOM BAR WILL BE NOTCHED TO ACCOMMODATE WEATHERSEAL ON THE EXTERIOR (OUTER ANGLE).
- 11.3 IF PVC GUIDE WEATHERSEAL IS ADDED TO THE DOOR AT A LATER TIME, THE BOTTOM BAR WILL NEED TO BE NOTCHED AN ADDITIONAL 1" PER SIDE TO ACCOMMODATE THE GUIDE WEATHERSEAL.

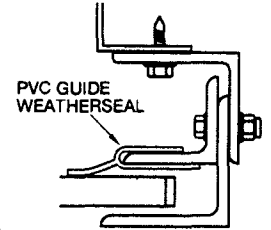

STEP 12 - BETWEEN JAMB MOUNT (OPTION)

- 12.1 CHECK THE HEIGHT AND WIDTH OF THE OPENING.
- 12.2 CHECK IF THE DOOR JAMBS ARE PLUMB.
- 12.3 CHECK IF THE FLOOR AND HEADER ARE LEVEL.

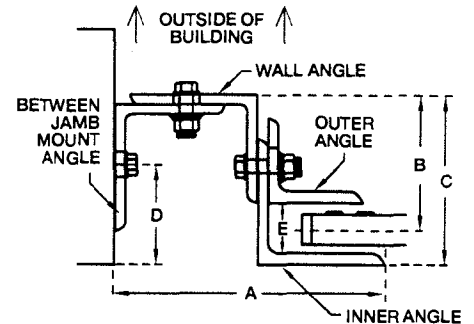

- 12.4 THE BETWEEN JAMB ANGLES MUST BE INSTALLED PLUMB AND LEVEL TO EACH OTHER EVEN IF JAMB IS NOT PLUMB AND FLOOR IS SLOPED.
- 12.5 EVENLY SPACE WALL ANGLES INSIDE OPENING SO THAT THE DISTANCE BETWEEN THEM IS SHOWN BELOW.

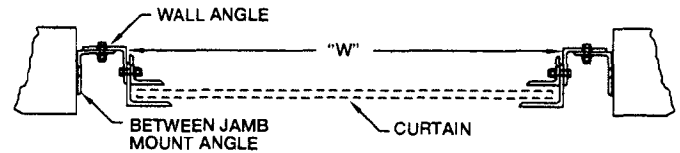

GUIDE TYPE	"W" DIMENSION
ALL NON-WINDLOCKS	BARREL + 1"
MALLEABLE WINDLOCKS	BARREL + 1.3/4"
10 IN. DIAMETER BARREL	BARREL + 2"

GUIDE DIMENSIONS - BETWEEN JAMBS					
TYPE	A	B	C	D	E
2	5.7/8"	3.3/16"	4"	2.9/16"	1.1/4"
3	6.3/8"	3.9/16"	4.3/8"	2.15/16"	1.1/4"
4	6.3/4"	3.15/16"	4.3/4"	2.3/4"	1.1/4"
2 (W/L)	6.3/8"	3.3/16"	4"	2.9/16"	1.1/2"
3 (W/L)	6.3/8"	3.9/16"	4.3/8"	2.15/16"	1.1/2"
4 (W/L)	6.3/4"	3.15/16"	4.3/4"	2.3/4"	1.1/2"
5 (W/L)	6.3/4"	4"	4.3/4"	2.3/4"	1.1/2"
6 (W/L)	8.3/4"	6.1/4"	7.1/4"	3.1/2"	1.1/2"

BETWEEN JAMB OPENING DEDUCTIONS = THEORETICAL "NEW" OPENING	
TYPE	DEDUCTION
2	12"
3	12"
4	12.3/4"
2 (W/L)	12.3/4"
3 (W/L)	12.3/4"
4 (W/L)	13.1/2"
5 (W/L)	13.1/2"
6 (W/L)	17.1/2"

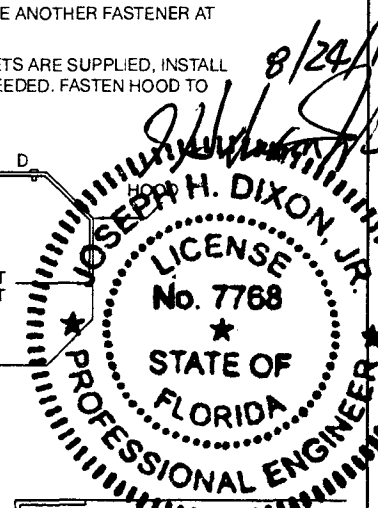

8/24/12